

TRISTAR

Digital Meters

Installation and Operation Manual

Version: TS-M-2
Version: TS-RM-2



8 Pheasant Run
Newtown, PA 18940 USA
email: info@morningstarcorp.com
www.morningstarcorp.com

TS-RM-2 Dimensions in inches [mm]

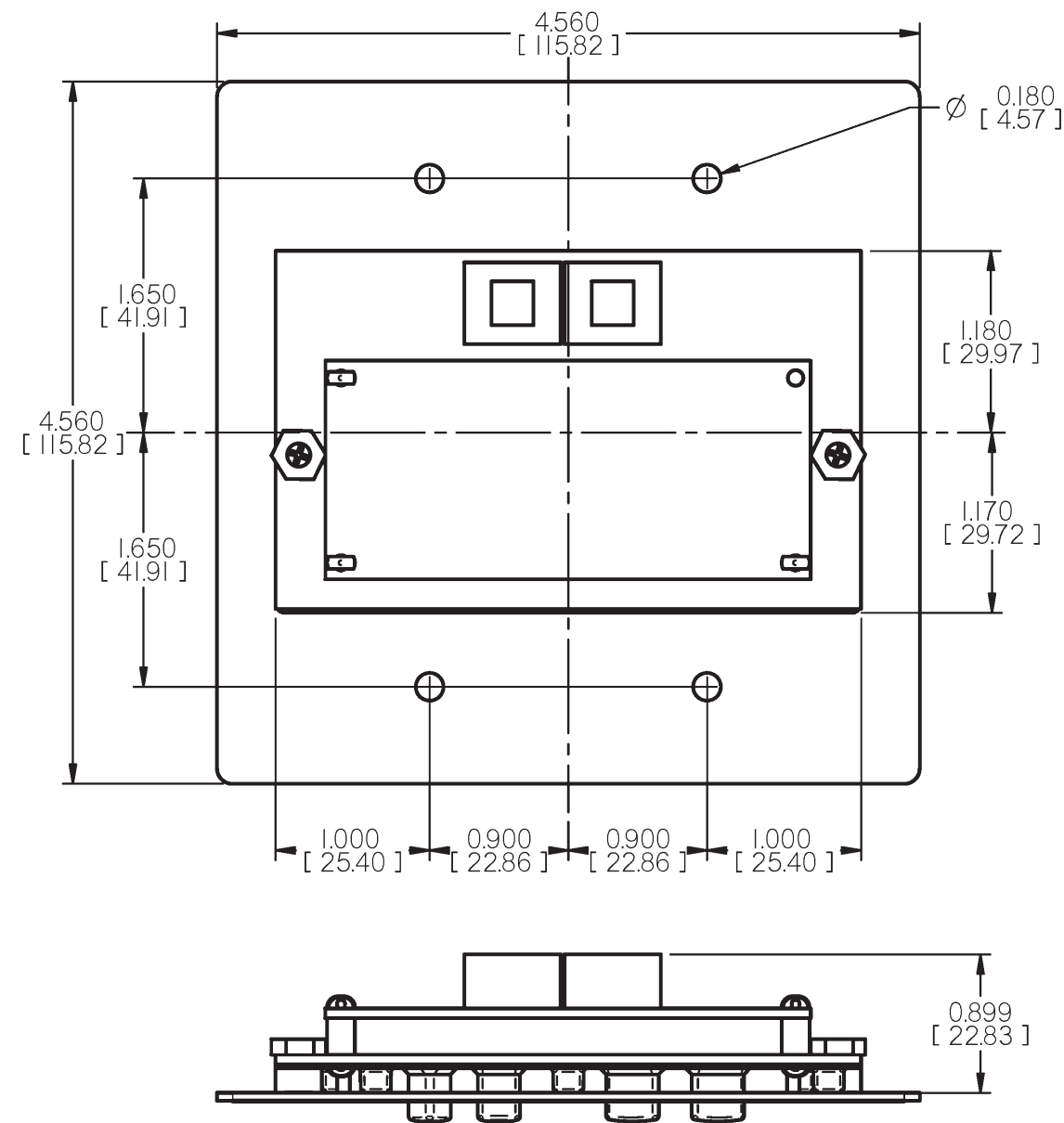

Contents

1.0 Important Safety Information	4
2.0 Meter Description	6
2.1 Meter Versions	7
2.2 General Use	7
3.1 General Information	9
3.0 Installation	9
3.2 TS-M-2 Install (single TriStar)	10
3.3 TS-RM-2 Install (single TriStar)	12
3.4 Multi-TriStar Network Setup	14
4.0 Operation	21
4.1 Backlighting	22
4.2 Single TriStar System	23
4.3 TriStar MeterBus Networks	35
5.0 Troubleshooting	40
6.0 Warranty	43
7.0 Technical Specifications	44

1.0 Important Safety Information

Save These Instructions

This manual contains important safety, installation and operating instructions for the TriStar Meter 2 digital displays.

The following symbols are used throughout this manual to indicate potentially dangerous conditions or mark important safety instructions:



WARNING:

Indicates a potentially dangerous condition. Use extreme caution when performing this task.



CAUTION:

Indicates a critical procedure for safe and proper operation of the controller.



NOTE:

Indicates a procedure or function that is important for the safe and proper operation of the controller.

Safety Information

- Read all of the instructions and cautions in the manual before beginning installation.
- There are no user serviceable parts inside the TriStar Meter 2. Do not disassemble or attempt to repair.
- There are no fuses or disconnects inside the TriStar Meter 2. Do not attempt to repair.

Installation Safety Precautions (Local Meter)

- Disconnect all power sources from the controller before mounting the TS-M-2 local meter.
- Use the supplied RJ-11 meter cable to connect the meter to the controller.
- Bend the power conductors in the conduit wiring box so that they do not touch the back of the meter.
- Apply silicon gel to the RJ-11 connections on the meter and the controller for maximum protection from corrosion.

Installation Safety Precautions (Remote Meter)

- Disconnect all power sources from the controller before opening the conduit box to connect the meter.
- Mount the TriStar Meter 2 indoors. Prevent exposure to the elements and do not allow water to enter the meter.
- Protect the RJ-11 wiring with grommets, conduit, and wire clips as necessary.
- Apply silicon gel to the RJ-11 connections on the meter and the controller for maximum protection from corrosion.

About this Manual

This manual provides detailed installation and usage instructions for the TriStar Meter 2 digital meters. Only qualified electricians and technicians who are familiar with solar system design and wiring practices should install the TriStar Meter 2. The usage information in this manual is intended for the system owner/operator.

2.0 Meter Description

TriStar controllers are technically advanced and professional solar battery chargers and load controllers. Two digital LCD meters are available for the TriStar family of controllers, and their displays are identical. One version is mounted on the controller; the other is mounted in a remote location.

This manual will help you to become familiar with the TriStar meters' features and capabilities. Some of these follow:

- Intertek ETL Recognized for use with Morningstar's TriStar family of charge controllers
- Complies with CE and LVD standards
- Suitable for 12, 24, 48 Vdc systems
- Fully protected from wiring faults
- Controller-mounted and remote versions can be used together
- Extended LCD temperature rating (-20°C to +70°C)
- Multilingual display (English, French, German, Portuguese, Spanish)
- Displays aggregate system data from multiple TriStar controllers
- Manual Ah resets and equalization control for individual controllers and for multi-controller systems
- Diagnostic capabilities
- View internal logged data stored in TriStar controllers that have datalogging capability
- Remote version supplied with 30m (98.4 ft), cable may be shortened if needed
- Connections are by standard RJ-11 6-position modular plugs
- 5-year standard warranty

2.1 Meter Versions

This manual covers two standard versions of a digital LCD meter that can be used with the TriStar family of solar controllers.

Version TS-M-2:

This local meter is provided as an assembly that replaces the TriStar front access cover. The TS-M-2 meter mounts to the TriStar controller.

Version TS-RM-2:

This remote meter is provided with a mounting plate and 30m (98.4 ft) of cable. It is identical to the TS-M-2 version except that the TS-RM-2 version can be mounted at some distance from the controller.

Both meters can display the full range of operating and diagnostic information for the TriStar's battery charging, load and diversion operating modes.

2.2 General Use

The meter will display a great deal of information about the TriStar controller and the operation of your system. In addition, the meters enable manual functions and controller diagnostics. These capabilities will increase your confidence that the system is working properly and will help you to improve system reliability, battery life, and system performance. It is worth the time getting to know your meter!

The organization of the display screens is described in Section

4.0. It is easy to move around the various display areas and to scroll up or down, and left or right using the four pushbuttons as indicated below:

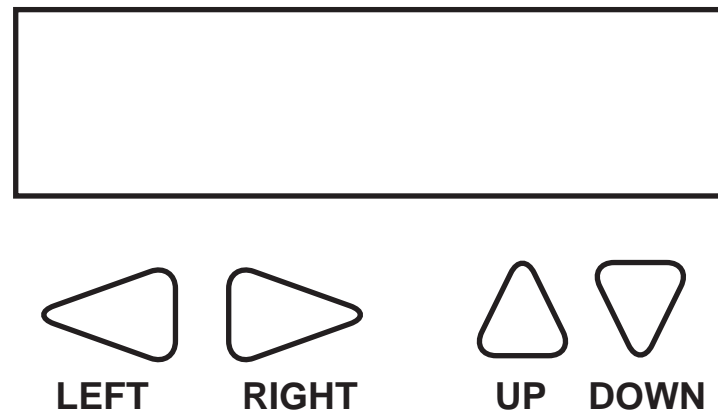

Due to power requirements, there is a limit of two meters that can be used with a single TriStar controller. There is also a limit of five meters per MeterBus network. Any combination of local and remote meter is permitted. Only one meter can have an active backlight at any given time.

3.0 Installation

The TriStar meters can be added to the controller when it is first installed, or at anytime after the controller has been in service.

3.1 General Information

The installation steps will differ depending on the number of TriStar controllers in the system.

For Single TriStar Systems:

- Mount the meter to the TriStar (TS-M-2) or in a remote location (TS-RM-2)
- Connect the meter cable to the RJ-11 connectors
- adjust the meter settings

For Systems with 2 or More TriStar Controllers:

- Use a meter or MSView PC software to adjust the MeterBus address of each TriStar controller in the system.
- Mount the meter to the TriStar (TS-M-2) or in a remote location (TS-RM-2).
- Connect the meter(s) and controllers to a HUB-1 (sold separately)
- adjust the meter settings



NOTE:

A TriStar meter may be connected to each TriStar in a multi-TriStar system without the use of a HUB-1. This configuration will not provide total system information; each meter will only display the information for one controller.



NOTE:
Both meters are rated for indoor use only.

There is a limit of two meters per single TriStar, five meters per MeterBus network. A single controller cannot power 3 meters.

When connected to a TriStar, the meter will automatically display the correct operating mode (Solar Charging / Load / Diversion). No adjustments to the meter are required.

If replacing or extending the meter cable, see Section 5.2.

3.2 TS-M-2 Install (single TriStar)

To install the local controller-mounted meter to a single TriStar, follow these steps in order:



CAUTION: Risk of Shock
Disconnect all power to the TriStar. The meter will not be damaged if connected with power, but power should be disconnected before the access cover is removed for safety.



CAUTION: Equipment Damage
Do not allow the local meter to hang or dangle from the RJ-11 cable when connected to the TriStar. The resulting stress on the cable could damage the meter or connectors.

1. Use a large phillips screwdriver to remove the 4 access cover screws.
2. Connect the RJ-11 cable to the meter and to the RJ-11

socket on the TriStar. Looking at the back of the meter, connect to the left RJ-11 socket.

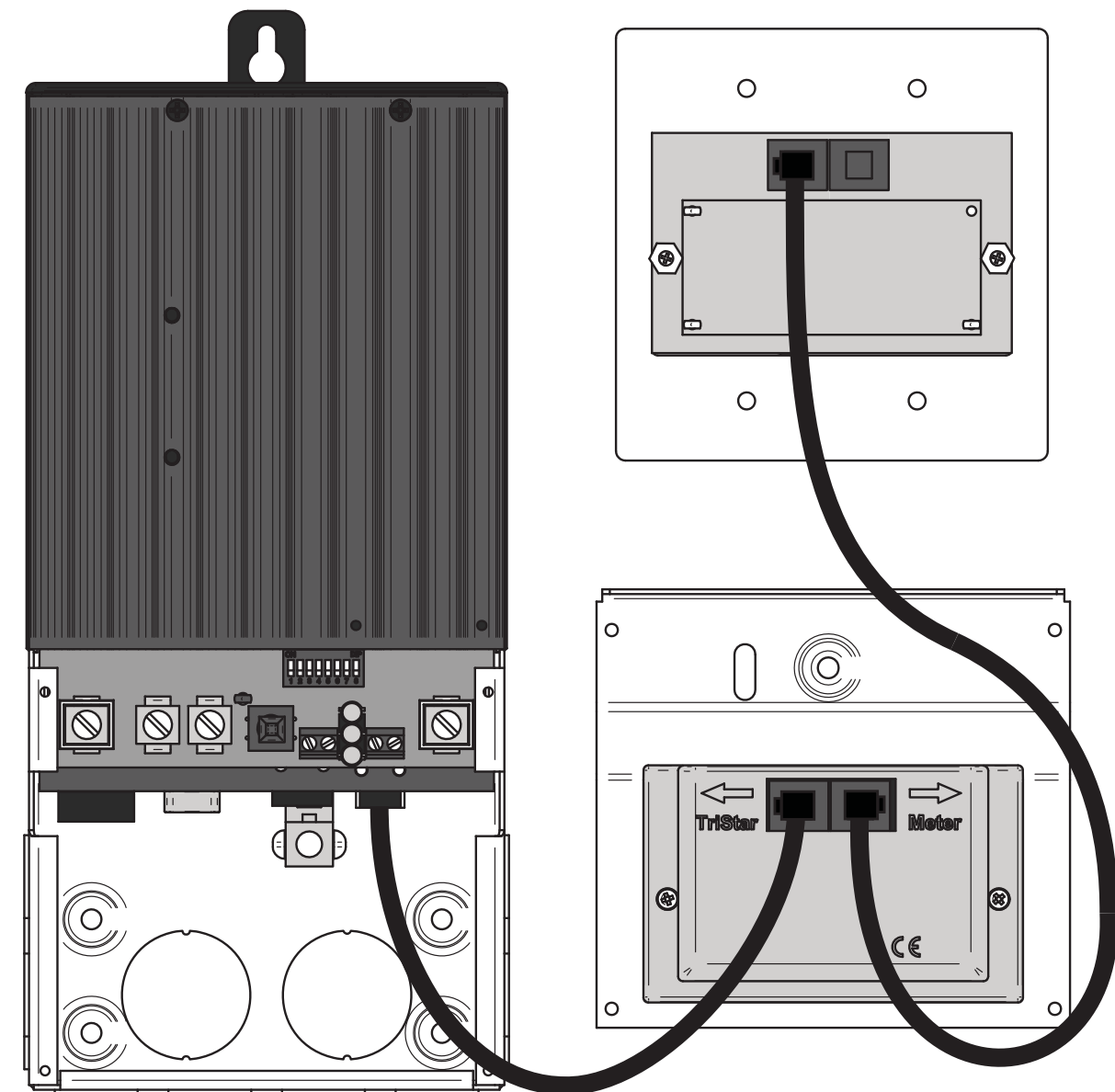

Figure 3-1. Meter connections



NOTE:

If the cable is connected to the wrong RJ-11 meter socket, there will not be any damage and the LCD display will remain blank. Move the cable connection to the other socket.

3. Carefully mount the TS-M-2 cover on the controller. Arrange the RJ-11 cable so that it does not interfere with the pushbutton operation or obscure the view of the LED indicators. Fasten the meter using the same 4 screws that secured the blank access cover.



CAUTION: Equipment Damage

Do not force the cover into place. If the large power wires are too high in the wiring compartment, pushing the meter onto the wires will damage the meter.

4. Mount the meter to the wall or cabinet. If a 2-gang box is not being used, cut a hole in the wall or cabinet sized per the TS-RM-2 dimensions provided on the inside cover of this manual.



NOTE:

2 remote meters can be installed if a TS-M-2 meter is not attached to the TriStar controller.

3.3 TS-RM-2 Install (single TriStar)

The remote meter is designed to mount into a standard duplex (2-gang) box, or flush against a wall or cabinet with a proper sized hole.

1. Connect one end of the 30 meter cable to the TriStar RJ-11 socket (or to the open socket if a TS-M-2 meter is mounted to the TriStar).
2. Connect the other end of the cable to the left socket (looking at the back) of the remote meter. See the diagram in 2.2.
3. Confirm the meter is working before mounting the meter.

3.4 Multi-TriStar Network Setup

Multiple TriStar controllers can be networked together using a Morningstar *MeterBus Communication Hub* (HUB-1) and RJ-11 cables. Networking controllers together on a MeterBus network allows one or more TriStar digital meters to communicate with all controllers on the network. This enables the display of total system data on the meter. Additionally, each individual controller's data may be viewed in separate menus.

To install either version meter in a MeterBus network, follow these steps in order:

Step 1 - Program Unique MeterBus Addresses

Each device on the MeterBus network must have a unique MeterBus address. All TriStars have a default MeterBus address of 1. Choose a controller to be controller #1 and mark it with a pen or sticker. This controller will keep the default MeterBus address 1.

There are two ways to program the remaining TriStars with unique addresses. TriStar PWM controllers can only be modified using Morningstar MSView PC software. TriStar MPPT controllers can be modified with MSView or directly from the TriStar Meter 2 *Advanced Setup* menu. Instructions for both methods are provided.

Modify the MeterBus Address with the TriStar Meter 2

1. Connect a TriStar local or remote meter to the second TriStar in the system.
2. Wait for the meter to power up and detect the connected TriStar. Once the meter has fully started, scroll to the bottom

of the main menu to the Logged Data screen. Press and hold the down pushbutton for 3 seconds until the Advanced Setup menu appears. See the Advanced Setup menu topic in section 4.2 for more details on how to access this menu.

3. In the Advanced Setup menu, scroll down to the MeterBus Address screen. Scroll left or right to increment/decrement the MeterBus address to the desired value.
4. When finished, push the up pushbutton to exit the menu. The LEDs on the controller should display a fault sequence indicating that memory has been modified.
5. Cycle power to the controller to reset the fault condition.
6. Disconnect the meter from the second controller. Repeat steps 1 - 5 for each additional TriStar in the system, programming each controller with addresses 3, 4, 5, etc. A maximum of 15 TriStar controllers are possible on a single MeterBus network.



NOTE:

The Morningstar Relay Driver has a default factory MeterBus address of 9. If a RelayDriver is present in the system, skip address 9 when programming the TriStars and resume numbering at address 10.

Modify the MeterBus Address using MSView PC Software

Morningstar's MSView PC software is available for free on our website. Download the latest version and install it. Follow these steps in order to change the MeterBus address:

1. Open MSView and select the setup wizard for your model TriStar controller from the *Tools* menu.
2. If custom settings are already programmed, read the set-

tings out first and then edit them. If one of the standard battery settings is used (most common), click “Create New”.

3. Click “Next” until the *Communications Settings* dialog appears. Change the MeterBus address to the desired address.
4. Click “Next” until the end of the wizard. Then click the Program button to load the new settings. Connect the TriStar with a serial cable to the computer, choose the connection settings, and click “Next” to program the controller.
5. Repeat steps 1-4 for each TriStar in the system, programming each controller with addresses 3, 4, 5, etc. A maximum of 15 TriStar controllers are possible on a single MeterBus network.



NOTE:

The controller does not have to be configured to use custom settings. When the MeterBus address is changed in custom settings memory, the programmed address is used for all modes of operation.

Step 2 - MeterBus Network Connections

After all TriStar controllers have been programmed with unique MeterBus addresses, the controllers must be networked together using one or more *MeterBus Communication Hubs* (HUB-1). Be careful not to overload a single TriStar in the system with too many meters, hubs, or other MeterBus devices. If the system will have multiple meters, wire each meter to a different TriStar. If possible, do not connect a meter to the same TriStar that provides power to the hub(s).

Following are a list of network rules and example networks.

Network Rules

- ✓ A maximum of 15 devices are allowed on a single MeterBus network. TriStar digital meters are not included in the device count.
- ✓ Ports 1 - 4 on the MeterBus Communication Hub are isolated ports. There is no power output on these ports.
- ✓ Ports A & B are not isolated from each other, but are isolated from ports 1-4.
- ✓ A TriStar must be connected to *Input Power Port B* to power the hub. When linking multiple hubs, *Power Out Port A* is connected to *Input Power Port B* of the following hub. (see Example Network # 3, pg. 20)
- ✓ DO NOT connect a TriStar to Power Out Port A
- ✓ Connect each additional TriStar in the system to ports 1 through 4
- ✓ Avoid connecting more than two Hubs, Meters, Relay Drivers or other devices to a single TriStar meter port. See the example networks for more details.

Example Network #1

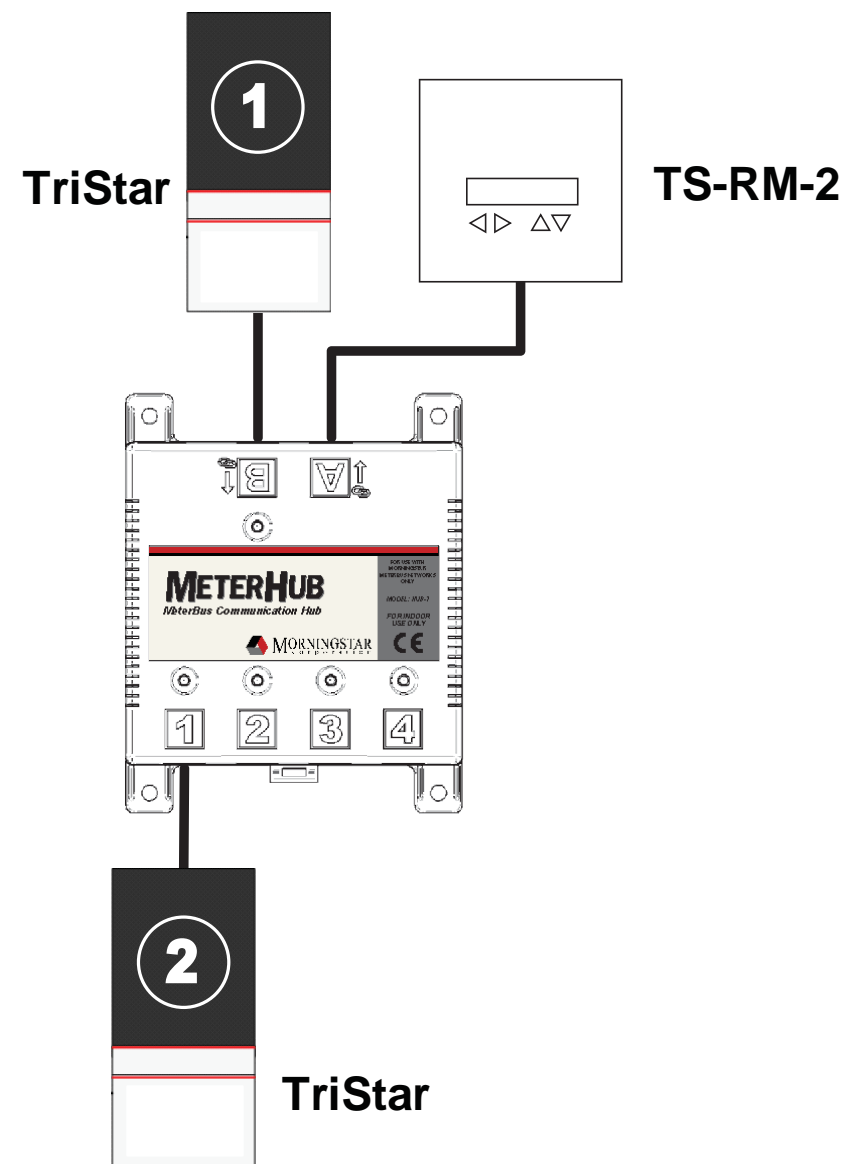

Figure 3-2. A simple two TriStar system with Remote Meter.

- TriStar 1 provides power both to a hub and to a single Remote Meter connected to Output Power Port A.
- TriStar 2 is connected to Port 1 on the Hub and is electrically isolated from TriStar 1.



NOTE:

Electrical isolation protects controllers, cables, and other system equipment from damaged due to poor or disconnected system grounds.

Example Network #2

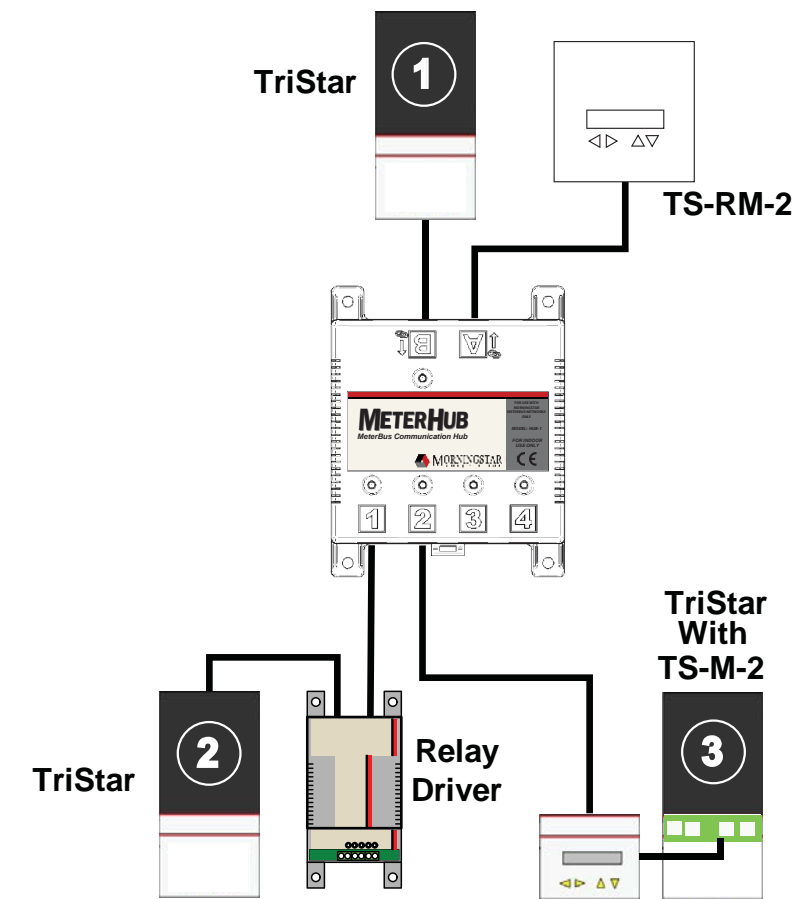

Figure 3-3. A medium-sized network with 3 TriStars, 2 meters, and a Relay Driver.

- TriStar 1 provides power to the hub and Remote Meter.
- TriStar 2 powers the Relay Driver and TriStar 3 powers the Local Meter. It is good practice to distribute the network meters and Relay Driver as shown to avoid loading a single TriStar with all of the network accessories.
- All three TriStars are isolated from each other in this system.



NOTE:

Information is shared across the entire MeterBus network. A meter can be connected anywhere in the system and will always show full aggregate system information as well as information about each controller on the network. This is true regardless of the meter model (TS-M-2 / TS-RM-2).

Example Network #3

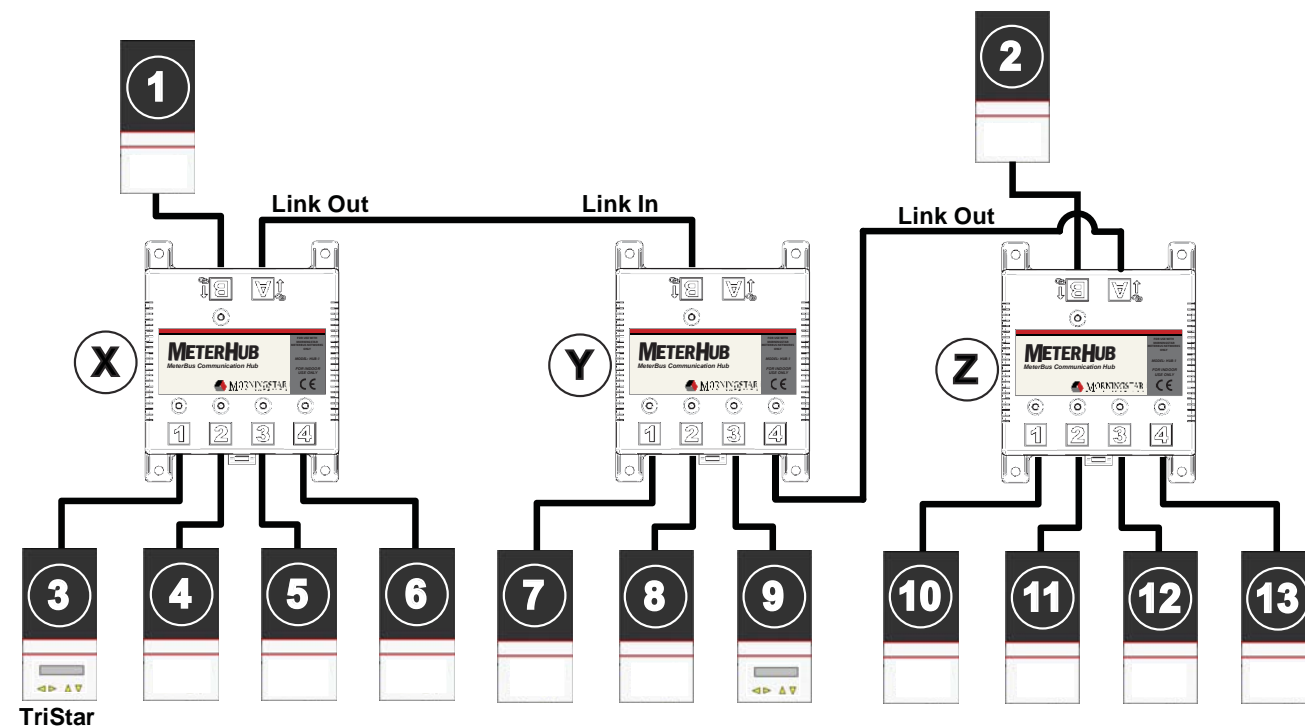

Figure 3-4. A large multi-hub network with 3 hubs, 13 TriStars, and 2 meters.

- TriStar 1 provides power to hubs X & Y. Do not daisy-chain more than 2 hubs.
- TriStar 2 provides power to hub Z to avoid overloading TriStar 1 with three hubs.
- Power Out Port A (Link Out) of hub Z is connected to Port 4 on hub Y so that communication is maintained between all 3 hubs.
- TriStars 3 & 9 each power a TriStar Local Meter.
- All TriStars are electrically isolated.

4.0 Operation

The four pushbuttons are in the shape of directional arrows. Changing a display screen will be in the direction of the arrow (up or down / left or right).

The information displayed and the organization of the meter screens differs depending on the number of TriStar controllers connected to the meter.

The exact menu structure for each supported controller is provided on separate meter maps included with the TS-M-2 and TS-RM-2 meters. This section discusses how to use the meter and adjust settings. It also covers important details about the menu structure.

4.1 Backlighting

The first push of any of the four meter pushbuttons will turn on the backlight. The backlight will remain on for 5 minutes from the last button press.



NOTE:

When turning on the backlight, there is no change in the display. The second press of any pushbutton will then change the display screen. This applies to both TS-M-2 and TS-RM-2 meter versions.



NOTE:

Only one meter will be backlit at a time. Pushing a button on a second meter on the network will automatically turn off the backlight on the first meter.

If the meter is connected to a TriStar PWM controller, the backlighting will begin to dim when battery voltage falls below 12.7 Volts. Backlighting will continue to dim proportionally to the battery voltage down to 10.0 Volts.

The backlight draws very low power and would consume less than 1 amp-hour of energy if it were turned on for a full 24 hour period.

4.2 Single TriStar System

The following section describes the TS-M-2 and TS-RM-2 operation in systems with one or more meters connected to a single TriStar controller. See section 4.3 for information pertaining to meters connected in multi-TriStar MeterBus networks.

Startup Displays

When the meter is plugged in and powered on, a sequence of startup screens will be displayed. Figure 4-1 below shows the startup sequence and provides a description of the information displayed on each screen. The startup screens are only displayed once when the meter is first powered on. This information can also be found under “TriStar Settings” during normal operation.

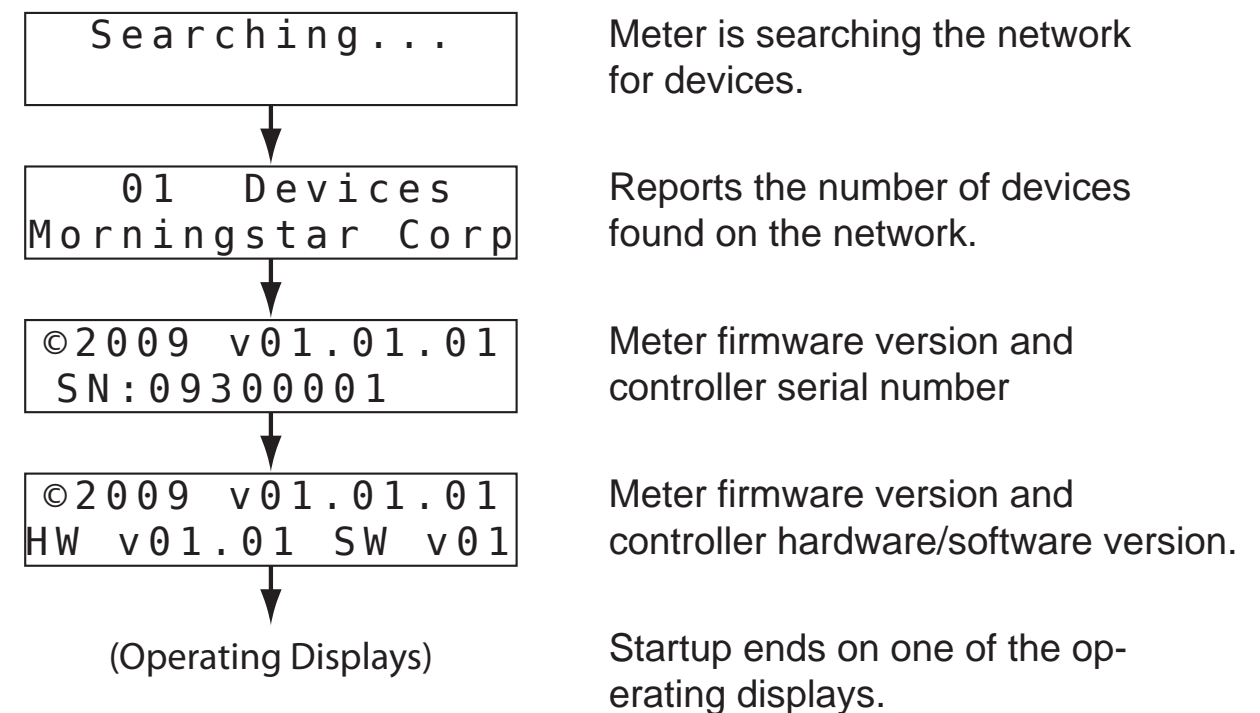

Figure 4-1. Startup screens

Operating Displays

Operating Display screens show the general operating information for the controller and cumulative information collected over time. These display screens are configured in a continuous circular loop and can be quickly accessed by scrolling either left or right.

The number of Operating Displays and the exact information displayed in each screen varies depending on the TriStar controller model and mode of operation (charge, load, diversion, etc). Refer to the meter map for the particular TriStar model purchased for detailed display information.

Figure 4-2 below shows an example layout of Operating Displays.

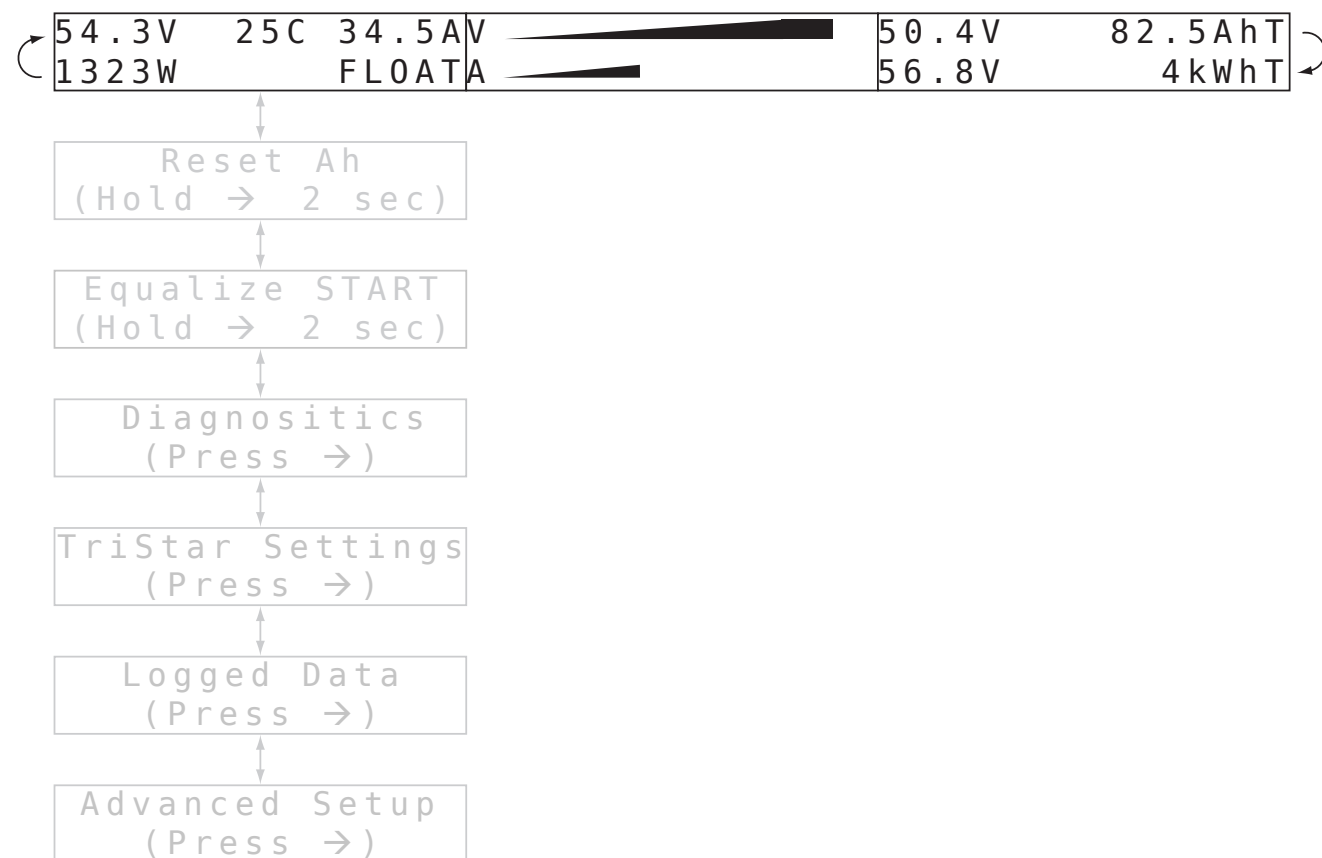

Figure 4-2. Example Operating Displays

Manual Operations

Screens located below the Operating Displays provide for various resets and manual functions. Additional display screens for resets and manual functions can be found in the Diagnostics menu. Figure 4-3 shows the location of the Manual Operation displays in the menu.

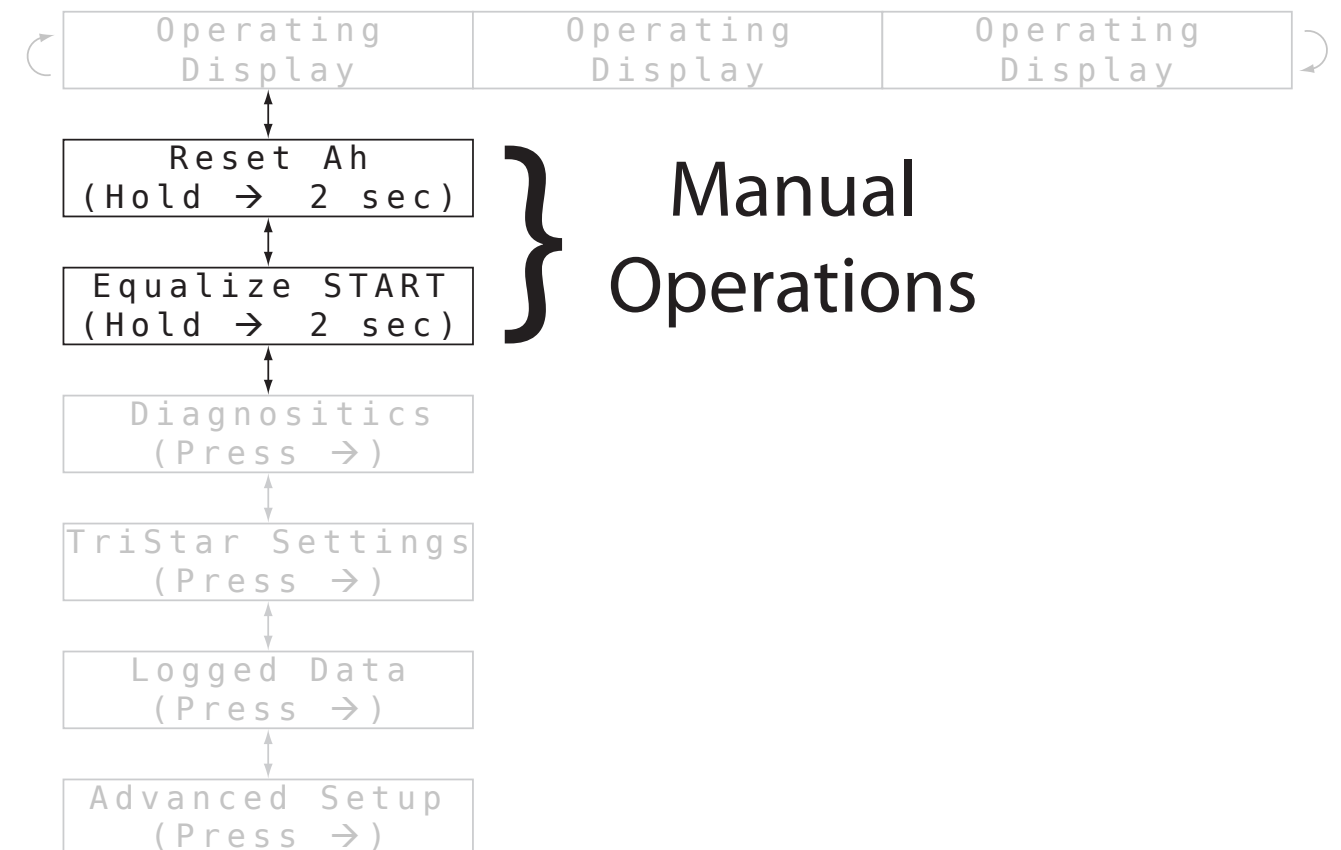

Figure 4-3. Manual Operation displays

Below is a full list of possible Manual Operation screens that can be displayed. Only operations that are relevant to the TriStar model and mode are displayed on the meter.

Reset Amp-hours

This display screen can be used to reset the *reset-able Ah* value. Additionally, this operation will reset the *battery minimum* and *battery maximum* values displayed in the Operating Displays. Hold the right arrow pushbutton for 2 seconds and

all three values will be reset to zero.

Equalize Start/Stop

Use this screen to initiate and terminate a manual equalization charge. Holding the right arrow for 2 seconds will start the equalization charge. Hold again for 2 seconds and equalization will stop. The SOC LEDs on the TriStar controller should flash the equalize start/stop sequence as defined in the controller Operator's Manual.



NOTE:

If the TriStar is configured for a battery type that does not have an equalize charge stage and an equalize operation is requested on the meter, the meter will display an "Error!" message indicating that an equalization charge cannot occur.

This Manual Operation screen will only be displayed for TriStars in *charge control* mode.

Load On/Off

Press and hold the right arrow pushbutton for 2 seconds to toggle the load on or off. If the controller is in low voltage disconnect (LVD), the load will reconnect for 10 minutes and then turn off automatically. There is no limit to the number of load reconnects in LVD.

This Manual Operation screen will only be displayed for TriStars in *load control* mode.

Battery Service (Diagnostics menu)

If battery service was performed early, this screen can be used to reset the service interval back to zero. The battery service reminder function is only enabled in custom settings.

Reset Total Amp-hours (Diagnostics menu)

This display will reset the total Ah and total kWh counters to zero. These values are normally not reset. However, if a new battery is installed for example, the owner may wish to reset these counters.

Diagnostics Menu

The Diagnostics Menu lists faults, alarms, and technical diagnostic information about the controller. This information may be useful for troubleshooting problems with the controller or solar system.

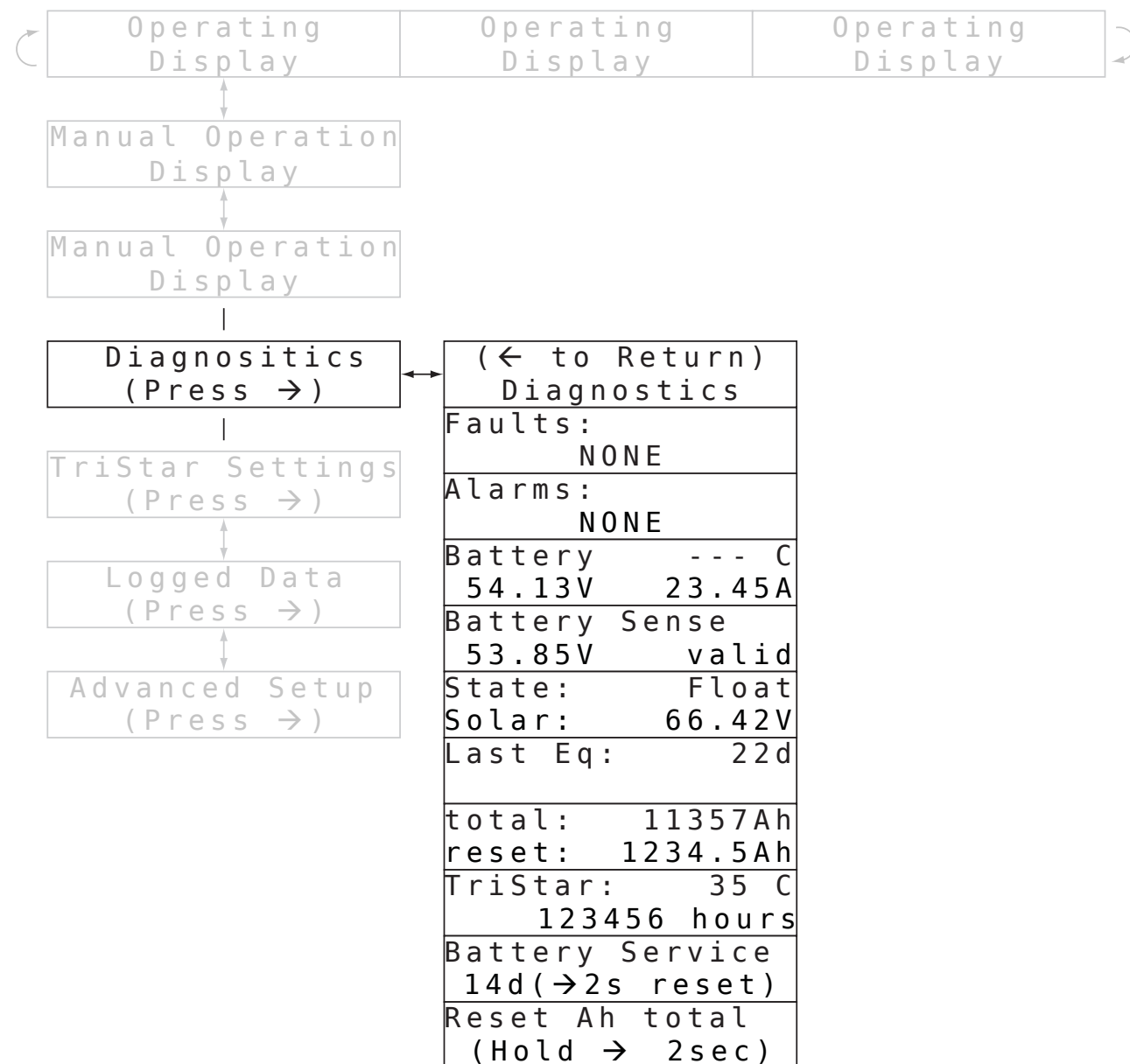

Figure 4-4. Diagnostics Menu

The exact information displayed in the Diagnostics Menu screens varies depending on the TriStar controller model and mode of operation (charge, load, diversion, etc). Refer to the

meter map for the particular model purchased for detailed display information.

Faults & Alarms

If a “Fault” or “Alarm” condition flashes on one of the main Operating Displays, navigate down to the Diagnostics Menu for a list of existing faults or alarms. The faults and alarms lists are always displayed on the first 2 screens of the Diagnostics Menu. Use the left and right pushbuttons to scroll through each list of faults and alarms, if any exist.

Using the Diagnostic Data

A full set of operating information is displayed below the fault and alarm display screens. These values are real-time and can change while the screen is being displayed. Following are a few notes about the diagnostic data:

- Battery temperature is displayed only if a Remote Temperature Sensor is connected to the controller.
- *Battery Voltage* is measured at the controller battery terminals.
- *Battery Sense* displays the actual battery voltage measured with the Battery Sense wires. If sense wires are not connected, the screen will display “invalid”.
- *Solar Voltage* is measured at the solar input terminals.
- *Last Eq* reports the number of days since the last equalization charge.
- TriStar temperature is the heatsink temperature on the controller.
- TriStar hours are the length of time the controller has been in operation..

TriStar Settings Menu

The TriStar Settings menu provides the following functions:

- confirms the setup and settings switches (DIP switches) are configured correctly
- provides hardware and software version numbers for technical support
- screens to select a language or change the units of temperature values on the meter

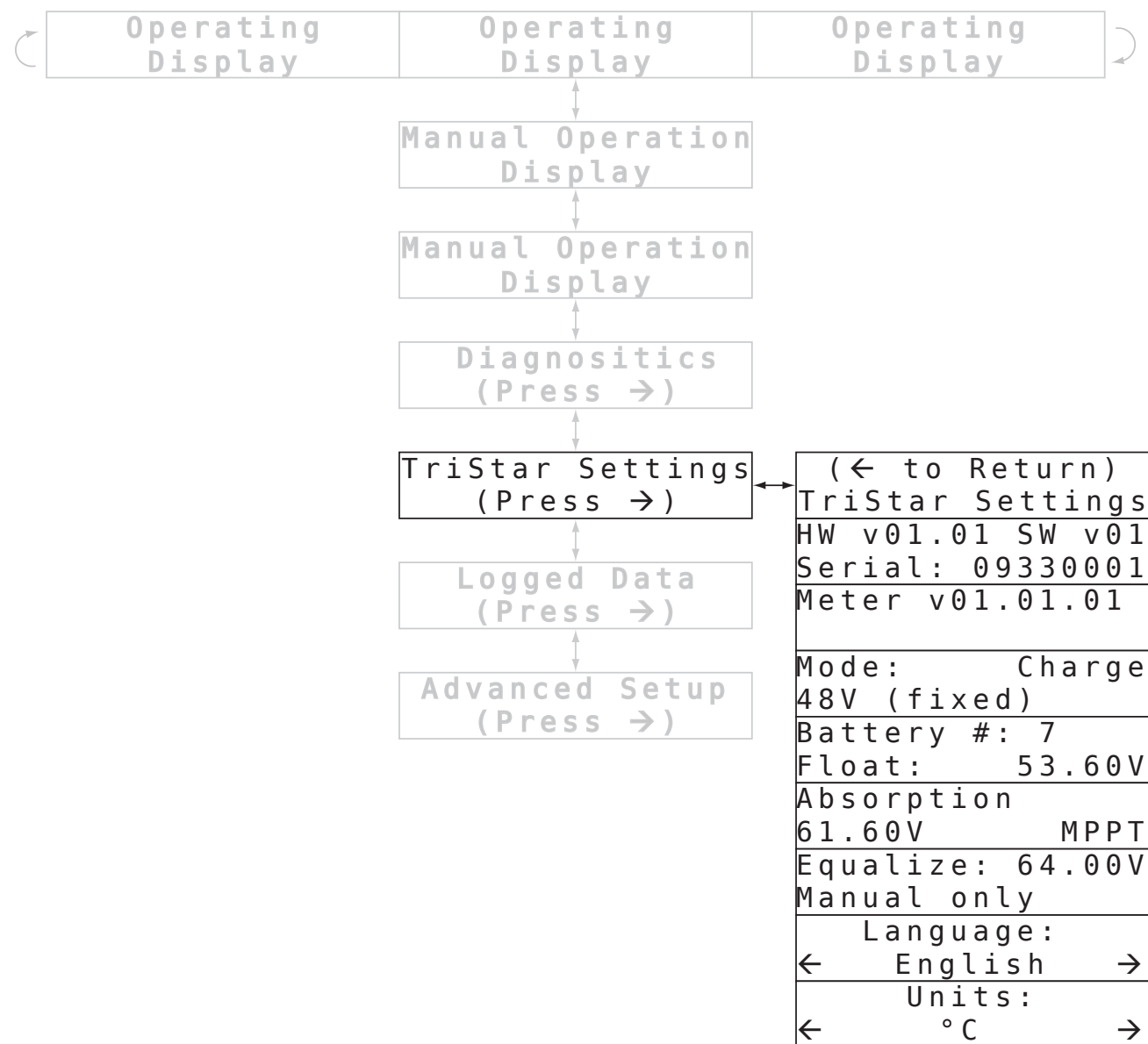

Figure 4-5. TriStar Settings Menu

Information Displayed

The first display screen shows the TriStar controller’s hardware and software revision as well as the controller serial number. These numbers are helpful if technical support is required.

The second display screen provides the meter hardware and software version. Following the version displays is a list of screens that provide specific information describing the operating mode and charging / load settings.

This information can be used to confirm that the controller has been adjusted and setup as desired. If any of these values do not seem correct, review the TriStar Operator’s Manual and confirm that the settings switches are configured correctly.

Language and Temperature Selections

The bottom two display screens provide for selecting a language or different temperature units.

Scrolling left or right on the Language screen provides selection of one of five languages:

- English
- French
- German
- Spanish
- Portuguese

Scrolling left or right on the Units screen allows the user to choose between °C and °F temperature display on the meter.

Logged Data Menu



NOTE:

Not all TriStar models support data logging or viewing logged data on the TriStar Meter 2. Refer to the meter map for the particular model purchased for detailed display information or consult the controller Operator's Manual.

The Logged Data menu displays select operating data that has been collected and stored in the TriStar controller's internal memory. The structure of the Logged Data menu is shown in Figure 4-6. Use the down pushbutton to scroll through the list of logged values. The right pushbutton scrolls back in time. The menu will wrap back to the beginning in both directions.

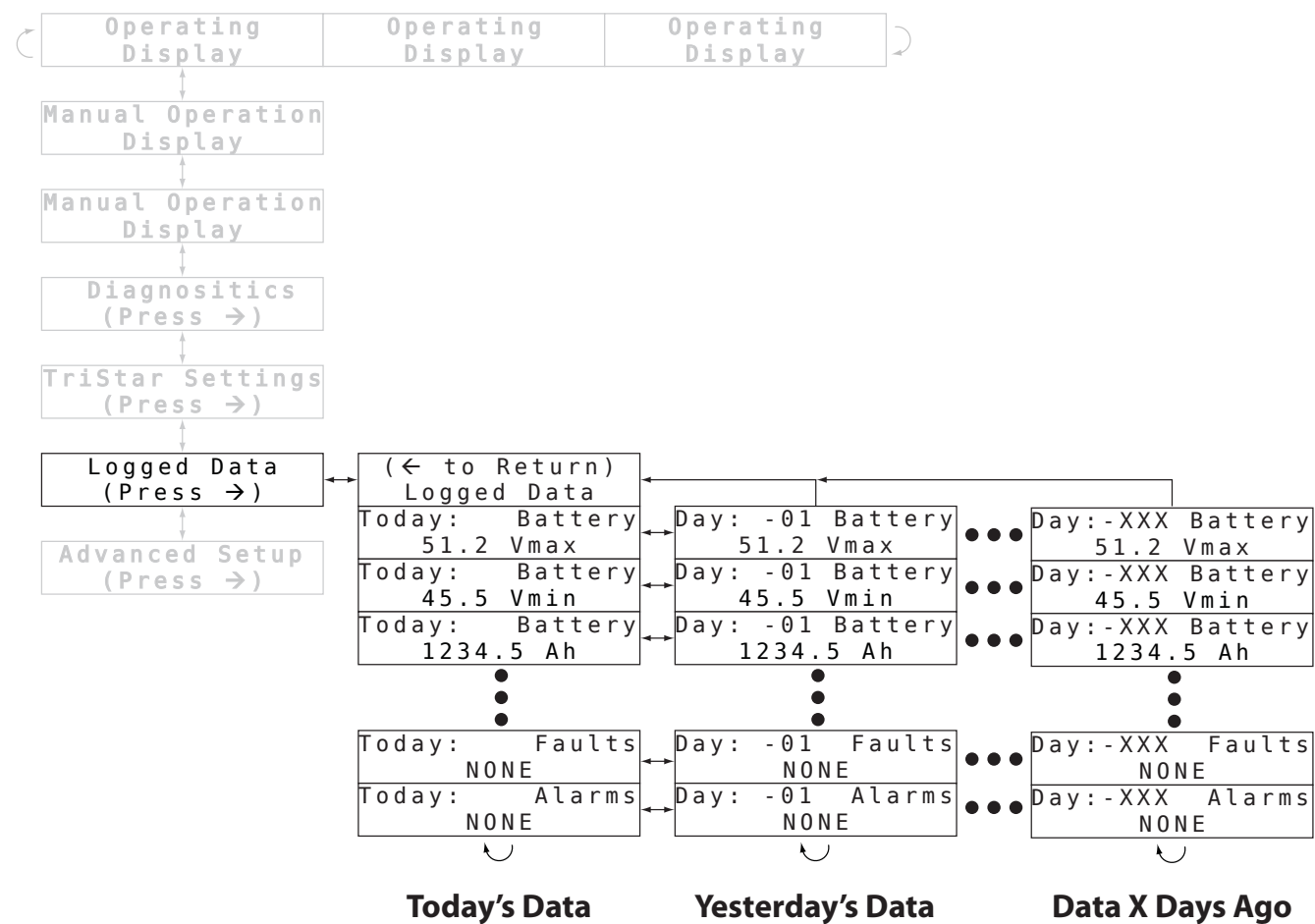

Figure 4-6. Logged Data menu

Advanced Setup Menu



NOTE:

Not all TriStar models support Advanced Setup on the TriStar Meter 2. Refer to the meter map for the particular model purchased for detailed display information or consult the controller Operator's Manual.

The Advanced Setup menu allows the user to modify certain operating settings. To enter the Advanced Setup menu, scroll down to the last display screen in the main menu. Press and hold the down pushbutton for 3 seconds. The Advanced Setup entry display will appear. Press the right pushbutton to enter the menu.

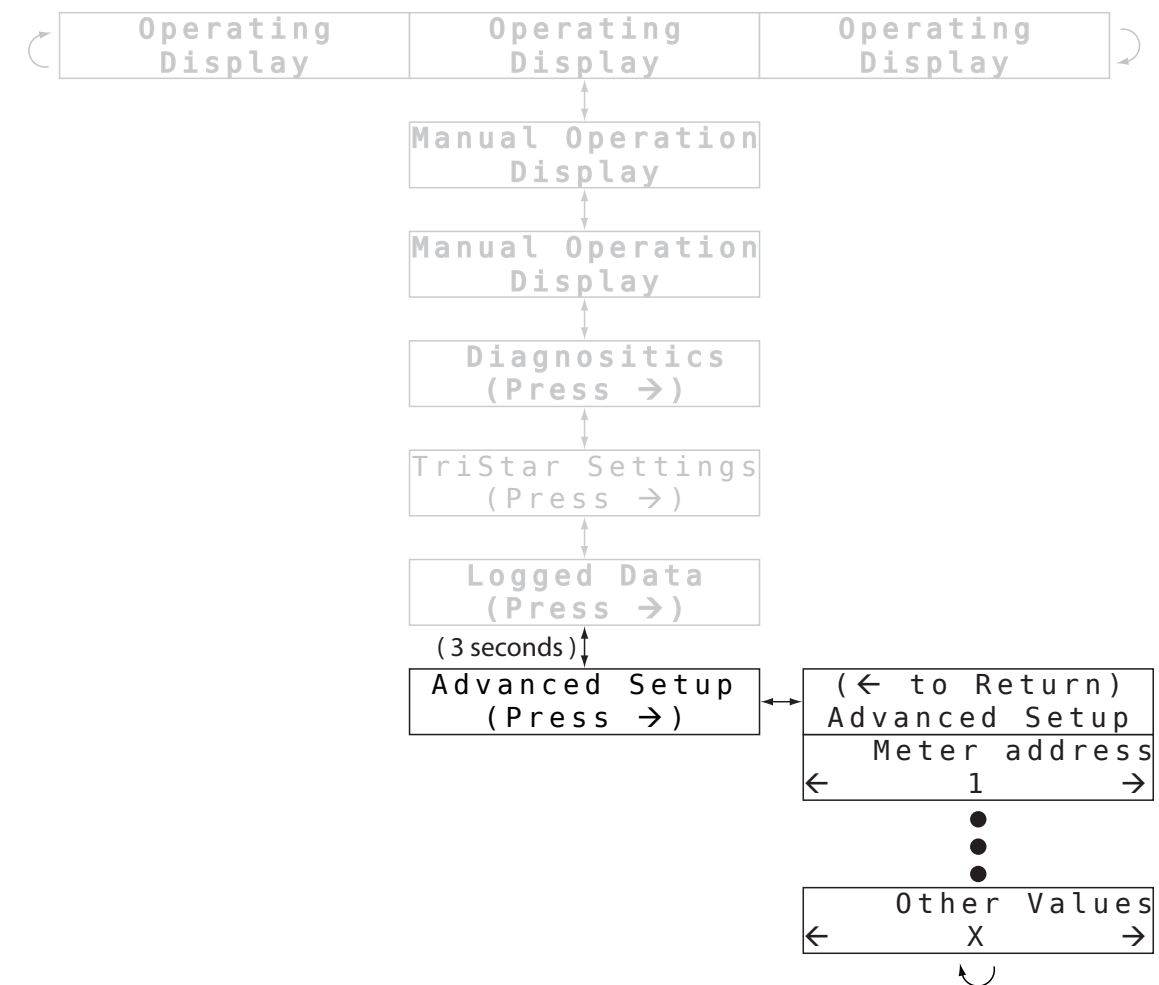

Figure 4-7. Advanced Setup menu

The setting values displayed in the Advanced Setup menu screens varies depending on the TriStar controller model and mode of operation (charge, load, diversion, etc). Refer to the meter map for the particular model purchased for detailed display information. Not all TriStar models support settings adjustment through the TriStar Meter 2.

For each value in the menu, use the left and right pushbuttons to modify the setting. The setting will be saved when the up or down pushbutton is pressed. Some settings may fault the controller when modified. The controller will need to be reset by removing and then reconnecting power.

4.3 TriStar MeterBus Networks

The following section describes the additional meter screens displayed on the TS-M-2 and TS-RM-2 in systems with two or more TriStar controllers on a MeterBus network. Section 4.2 covers the individual controller menus.

Startup Displays

When the meter is plugged in and powered on, a sequence of startup screens will be displayed. Figure 4-8 below shows the startup sequence and provides a description of the information displayed on each screen. The startup screens are only displayed once when the meter is first powered on. This information can also be found under “System Settings” in the System menu during normal operation.

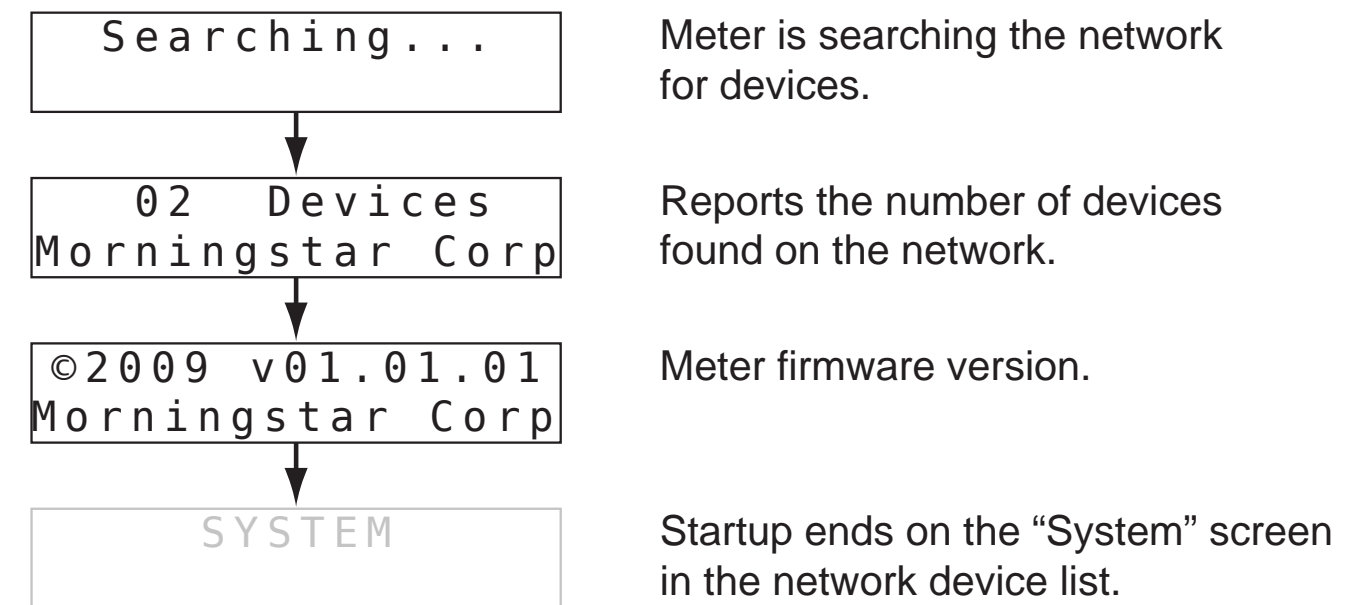

Figure 4-8. Startup Displays for Multi-TriStar Networks

Network Device List

The Network Device List is a top level menu that contains a screen for each controller on the network. There is also an additional “SYSTEM” screen that provides system-wide information.

An example Network Device List is shown in figure 4-9 below. The example system has two controllers: a charge controller and a TS-45 in Load mode.

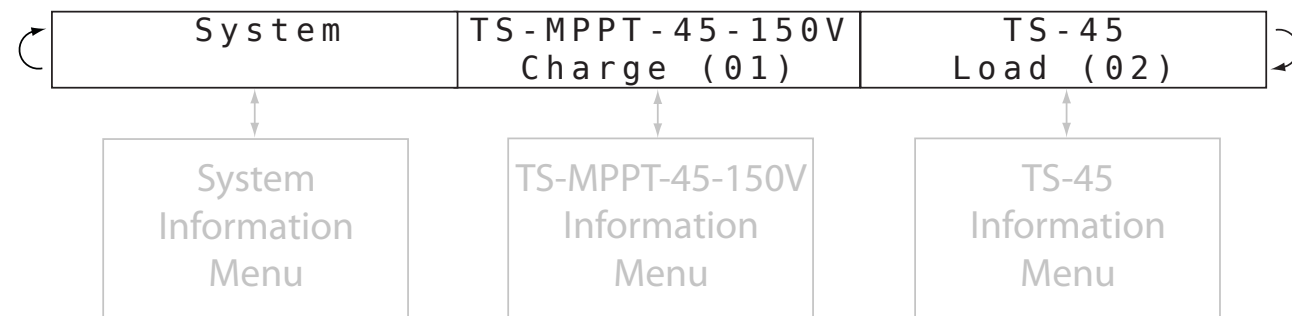

Figure 4-9. Network Device List

Each device screen displays the model number, the mode of operation, and the MeterBus address. Pressing the down button on any of the device screens will advance to the controller information menu. The information menu varies depending on the TriStar controller model and mode of operation (charge, load, diversion, etc). The structure of the controller information menus is described in Section 4.2. Refer to the meter map for the particular model purchased for detailed display information.

Pressing the down pushbutton on the “SYSTEM” screen will advance to the System Information menu. The System Information menu is a special menu that is described in the next topic.

System Information Menu

The System Information menu displays the following:

- Operating Displays show aggregate system data
- Manual Operation screens for system-wide control
- System Settings menu to adjust meter settings

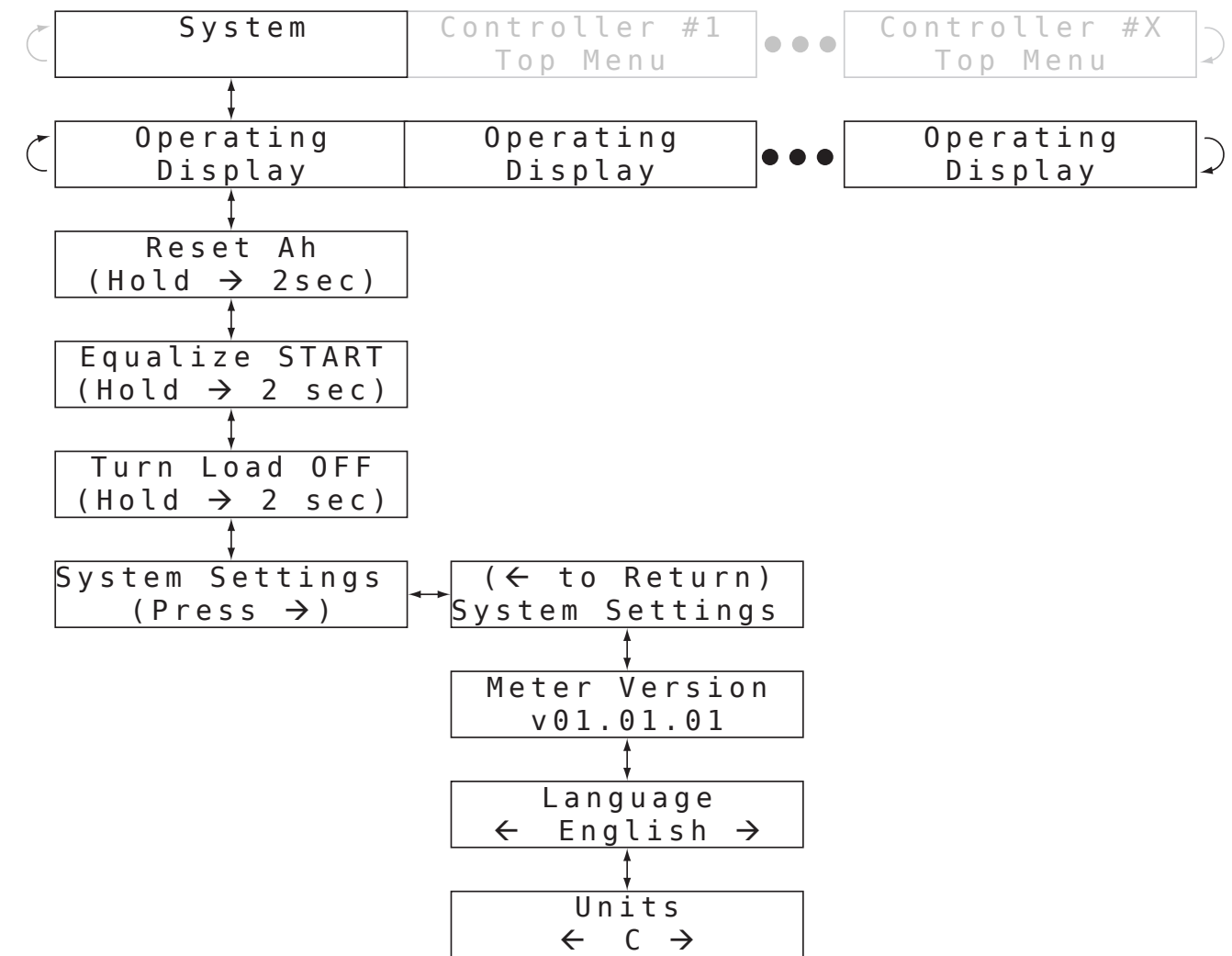

Figure 4-10. System Information menu.

System Operating Displays

The quantity and type of Operating Displays in the System Information menu depends on the controllers in the system.

If one or more charge controllers are in the system, the Operating Displays in Figure 4-11 will be included in the Operating Displays list.

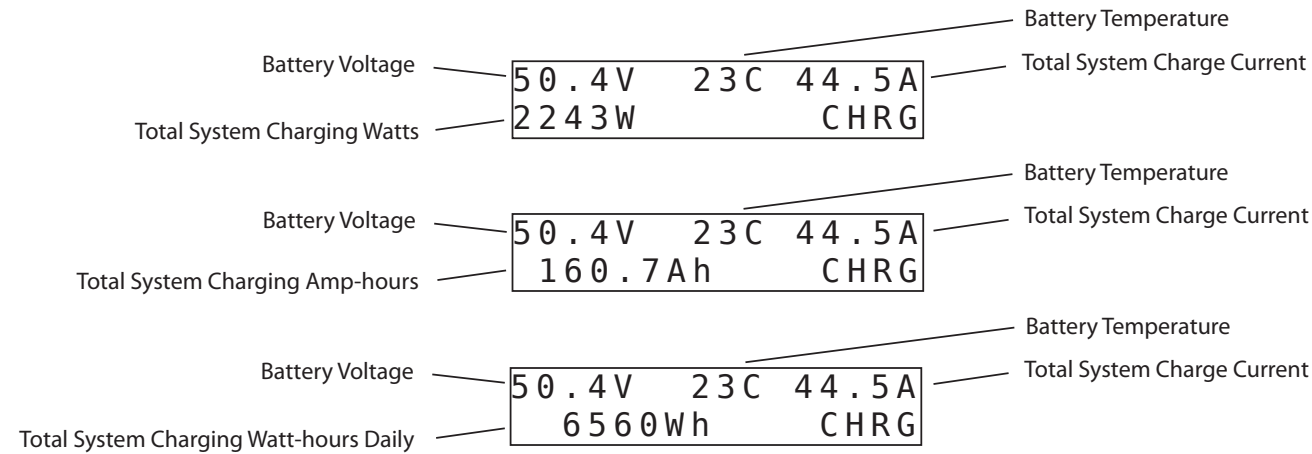

Figure 4-11. Total system charge Operating Displays

If one or more load controllers are in the system, the Operating Displays in Figure 4-12 will be included in the Operating Displays list.

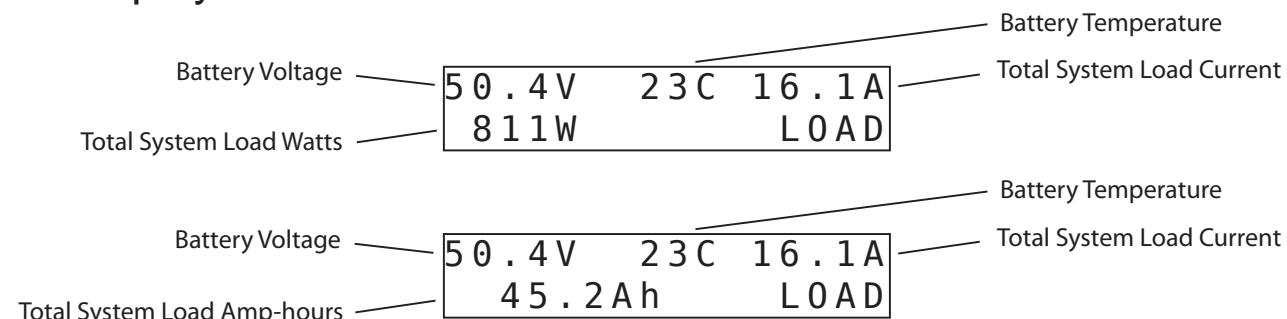

Figure 4-12. Total system load Operating Displays

If one or more diversion controllers are in the system, the Operating Displays in Figure 4-13 will be included in the Operat-

ing Displays list.

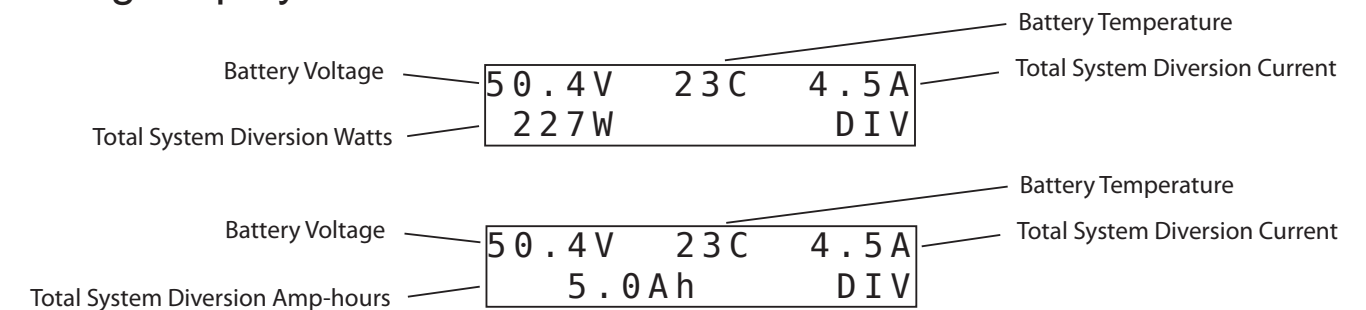

Figure 4-13. Total system diversion Operating Displays

System Manual Operation Displays

Display screens located below the Operating Displays provide for various resets and manual functions. These commands are broadcast across the network to all controllers. See the Manual Operations topic in Section 4.2 for more information.

System Settings Menu

This menu displays the meter hardware and software version and also provides adjustments for the meter language and temperature units.

5.0 Troubleshooting

The TriStar Meter 2 displays data transmitted digitally from the TriStar controller(s). There should not be any conflicts between the values displayed on the meter and information collected from the controller through other communication interfaces. For this reason, the meter troubleshooting focuses on mechanical and electrical issues with the meter and meter connection.

5.1 Troubleshooting Steps

There is no display:

- the RJ-11 cable may be plugged into the wrong connector socket - move to the other socket on the meter
- the connector may be loose in the socket - remove and reconnect, press firmly until the plug “clicks”
- there may be a break in the RJ-11 cable wire (see section 5.2)
- battery voltage may be too low, check the TriStar Operator’s Manual for minimum operating voltage.

Backlight is dim or does not light:

- if there is enough ambient light in the room, the backlighting may not be noticeable
- battery voltage may be too low, check the TriStar Operator’s Manual for minimum operating voltage.

The meter map provided does not match the meter display

- the meter map may not match the meter display due to software revisions, the latest maps are available for download on our website

- if there are substantial differences between the map and the display, either the wrong map is used or the controller is not configured for the correct operating mode

The meter does not respond to button pushes

- press the pushbutton down harder - it will not break
- try other pushbuttons to confirm one or more are working
- if others work, the faulty button may have dirt on the contact
- to clean:
 - disconnect the power
 - remove the 2 Phillips screws that fasten the meter to the cover plate
 - remove the meter assembly from the yellow button pad
 - clean the pushbutton contacts and circuit board contacts with alcohol and a cotton swab.
 - reassemble the meter

Dirt is trapped between the display and the label window

- to clean:
 - disconnect the power
 - remove the 2 Phillips screws that fasten the meter to the cover plate
 - remove the meter assembly from the yellow button pad
 - clean the label window and screen with a damp cloth and dry.
 - reassemble the meter

5.2 RJ-11 Cable Repair

The meter connecting cable is a standard 6-conductor telephone cable with RJ-11 modular connectors. If the cable or connectors are damaged, they can either be repaired or replaced.

A standard flat 6-wire phone cable should be used. With the RJ-11 connectors, the cable assembly appears as shown in figure 5-1.



Figure 5-1. Meter cable assembly

A 4-wire cable can also be used for shorter distances.

6.0 Warranty

The TriStar Meter 2 is warranted to be free from defects in material and workmanship for a period of FIVE (5) years from the date of shipment to the original end user. Morningstar will, at its option, repair or replace any such defective products.

CLAIM PROCEDURE

Before requesting warranty service, check the Operator's Manual to be certain that there is a fault with the TriStar Meter 2. Return the defective product to your authorized Morningstar distributor with shipping charges prepaid. Provide proof of date and place of purchase. To obtain service under this warranty, the returned products must include the model, serial number and detailed reason for the failure. This information is critical to a rapid disposition of your warranty claim. Morningstar will pay the return shipping charges if the repairs are covered by the warranty.

WARRANTY EXCLUSIONS AND LIMITATIONS

This warranty does not apply under the following conditions:

- Damage by accident, negligence, abuse or improper use.
- Unauthorized product modification or attempted repair
- Damage occurring during shipment

THE WARRANTY AND REMEDIES SET FORTH ABOVE ARE EXCLUSIVE AND IN LIEU OF ALL OTHERS, EXPRESS OR IMPLIED. MORNINGSTAR SPECIFICALLY DISCLAIMS ANY AND ALL IMPLIED WARRANTIES, INCLUDING, WITHOUT LIMITATION, WARRANTIES OF MERCHANTABILITY AND FITNESS FOR A PARTICULAR PURPOSE. No Morningstar distributor, agent or employee is authorized to make any modification or extension to this warranty.

MORNINGSTAR IS NOT RESPONSIBLE FOR INCIDENTAL OR CONSEQUENTIAL DAMAGES OF ANY KIND, INCLUDING BUT NOT LIMITED TO LOST PROFITS, DOWNTIME, GOODWILL OR DAMAGE TO EQUIPMENT OR PROPERTY.

*8 Pheasant Run
Newtown PA 18940
Email: info@morningstarcorp.com
www.morningstarcorp.com*

7.0 Technical Specifications

Electrical

Self consumption	7.5 mA (not backlit) 42.5 mA with backlighting
------------------	---

Mechanical

Mounting plate dimensions	116 x 116 mm(4.56 x 4.56")
Plate material	powder coated steel
Meter weight	0.23 kg / 0.5 lb TS-M-2 0.18 kg / 0.4 lb TS-RM-2
Connector type	RJ-11 (6-pin)
TS-M-2 cable	0.13 m / 5 in - 6 conductor
TS-RM-2 cable	30 m / 98.4 ft - 6 conductor
Cable temperature	60°C rating

Environmental

Operating Temperature	-40°C to +60°C
LCD temp. rating	-20°C to +70°C
Storage Temperature	-55C to +85C
Humidity	5-95 % (NC)
Tropicalization	conformal coating on both sides of circuit board

Certifications

CE
RoHS
ETL Recognized Component

*Specifications subject to change without notice.
Designed in the U.S.A.
Assembled in Taiwan.
MS-ZMAN-TSM2-01-A 09/09*